

THIS DRAWING IS INTENDED FOR GENERAL REFERENCE BY THE MECHANICAL TRADES FOR USE IN PLANNING THEIR WORK. IQ LABS, ASSUMES NO RESPONSIBILITY FOR THE ACCURACY OF THE DRAWING AND WILL NOT BE RESPONSIBLE FOR MECHANICAL ERRORS OCCASIONED BY THE USE OF THIS DRAWING

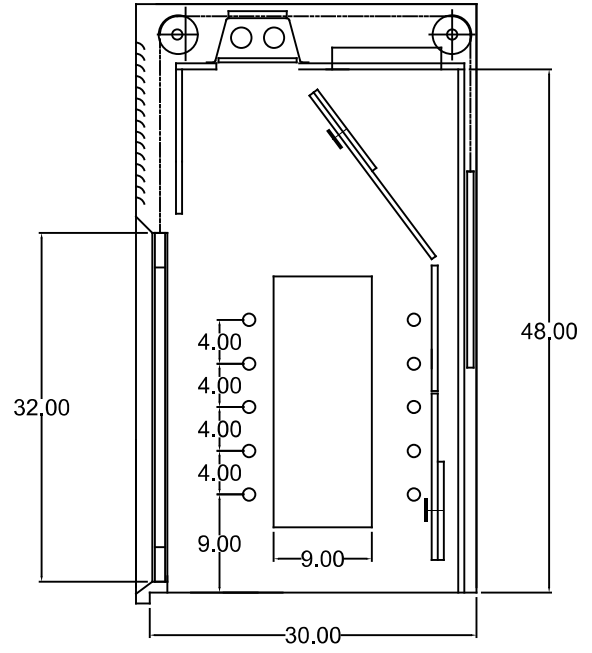

THIS DRAWING AND ALL INFORMATION THEREON IS THE PROPERTY OF IQ LABS, AND IS SUBJECT TO RETURN UPON REQUEST. IT IS CONFIDENTIAL AND MAY NOT BE SHOWN TO UNAUTHORIZED PERSONS OR REPRODUCED IN WHOLE OR PART WITHOUT WRITTEN PERMISSION OF IQ LABS. ALL AUTHORIZED REPRODUCTIONS SHALL BEAR THIS TITLE BLOCK.

JOB NAME
 2176 E LAKETON ST
 MUSKEGON, MICHIGAN 49442
 CUSTOMER

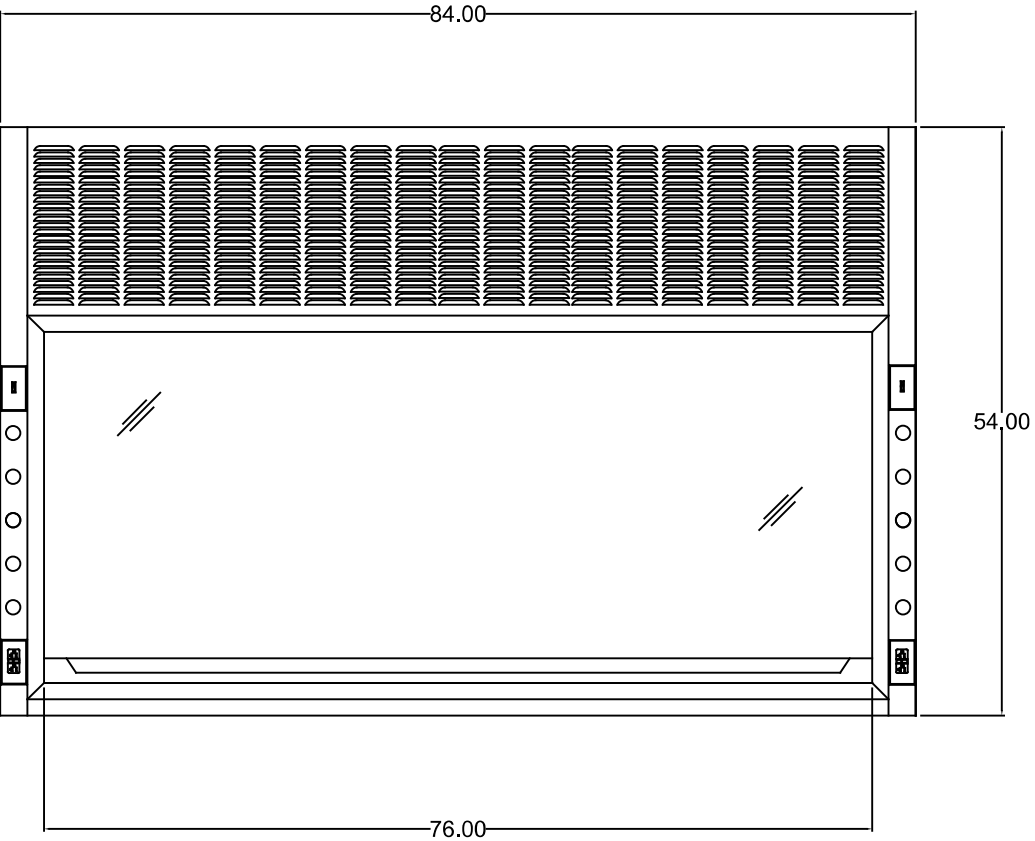

DWG. NO. BV8454